

PART NUMBER
OED-EL-8L

REV.
D

REV.	E.C.N. NUMBER AND REVISION COMMENTS	DATE
A	E.C.N. #10247.	9.30.96
B	E.C.N. #10BRDR.	1.7.98
C	E.C.N. #10BRDR. & REDRAWN IN 3D.	12.31.02
D	E.C.N. #11561.	3.23.09

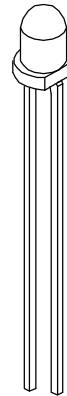
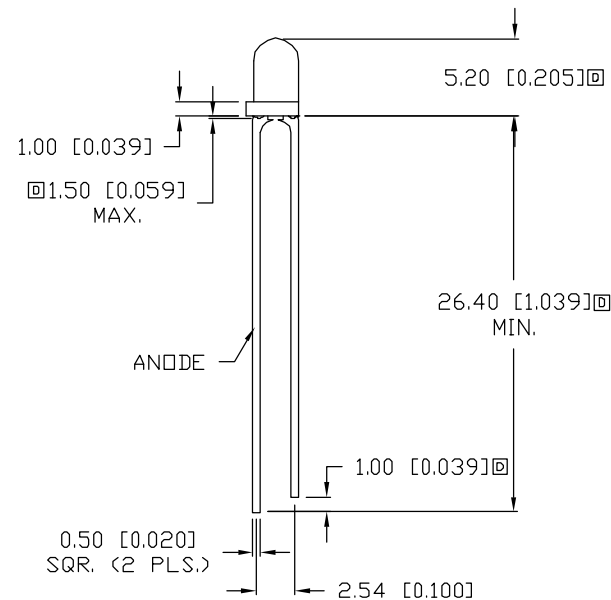
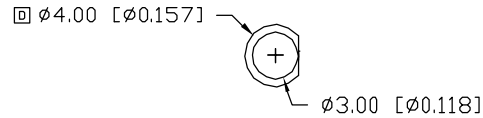

ELECTRO-OPTICAL CHARACTERISTICS $T_A=25^\circ\text{C}$ $I_f=20\text{mA}$

PARAMETER	MIN	TYP	MAX	UNITS	TEST COND
PEAK WAVELENGTH		940		nm	
SPECTRAL BANDWIDTH		45		nm	
□ FORWARD VOLTAGE		1.2	1.5	V_f	$I_f=20\text{mA}$
		1.4*	1.8*	V_f	$I_f=100\text{mA}$
		2.6*	4.0*	V_f	$I_f=1\text{A}$
REVERSE VOLTAGE			5.0	V_r	$I_r=10\mu\text{A}$
□ RADIANT INTENSITY	4.0	5.6		mW/SR	$I_f=20\text{mA}$
		35*		mW/SR	$I_f=100\text{mA}$
		390*		mW/SR	$I_f=1\text{A}$
□ HALF ANGLE		±17.5		degrees	

EPOXY LENS FINISH: WATER CLEAR

* $t_p < 100\mu\text{s}$, $TP/T=1\%$

LIMITS OF SAFE OPERATION AT 25°C

PARAMETER	MAX	UNITS
PEAK FORWARD CURRENT*	1	A
STEADY CURRENT	100	mA
POWER DISSIPATION	150	mW
DERATE FROM 25°C	-1.6	$\text{mW}/^\circ\text{C}$
□ OPERATING TEMP.	-40 TO +85	$^\circ\text{C}$
□ STORAGE TEMP.	-40 TO +85	$^\circ\text{C}$
SOLDERING TEMP.	+260	$^\circ\text{C}$
2.0mm FROM BODY		3 SEC. MAX

* $t_p < 100\mu\text{s}$, $tp/T=1\%$



*UNLESS OTHERWISE SPECIFIED TOLERANCES PER DECIMAL PRECISION ARE: X=±1 (±0.039), X.X=±0.5 (±0.020), X.XX=±0.25 (±0.010), X.XXX=±0.127 (±0.005). LEAD SIZE=±0.05 (±0.002), LEAD LENGTH=±0.75 (±0.030). MIN= +DECIMAL PRECISION -0.00 MAX= +0.00 -DECIMAL PRECISION

REV.
D

PART NUMBER
OED-EL-8L

CONFIDENTIAL INFORMATION
THE INFORMATION CONTAINED IN THIS DOCUMENT IS THE PROPERTY OF LUMEX INC. EXCEPT AS SPECIFICALLY AUTHORIZED IN WRITING BY LUMEX INC., THE HOLDER OF THIS DOCUMENT SHALL KEEP ALL INFORMATION CONTAINED HEREIN CONFIDENTIAL AND SHALL PROTECT SAME IN WHOLE OR IN PART FROM DISCLOSURE AND DISSEMINATION TO ALL THIRD PARTIES.



290 E. HELEN ROAD
PALATINE, IL 60067-6976
PHONE: +1.847.359.2790
US WEB: www.lumex.com
TW WEB: www.lumex.com.tw

T-3mm, 940nm INFRARED EMITTER, WATER CLEAR LENS.

RELIABILITY NOTE
OUR MANY YEARS OF EXPERIENCE DATA ACCUMULATION INDICATE THAT SOLDER HEAT IS A MAJOR CAUSE OF EARLY AND FUTURE FAILURE. PLEASE PAY ATTENTION TO YOUR SOLDERING PROCESS.

DRAWN BY: BC	CHECKED BY:	APPROVED BY:	DATE: 4.21.93
			PAGE: 1 OF 1
			SCALE: N/A

PART NUMBER
OED-EL-8L

REV.
D

REV.

SEE PAGE 1.

DATE

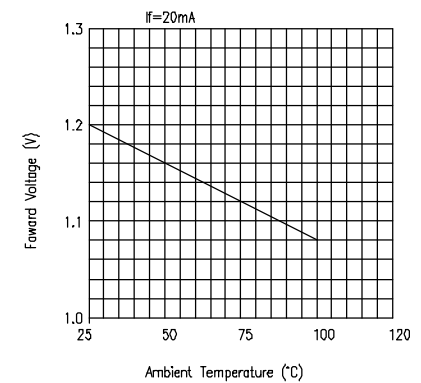
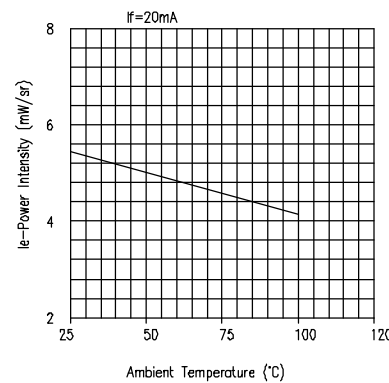
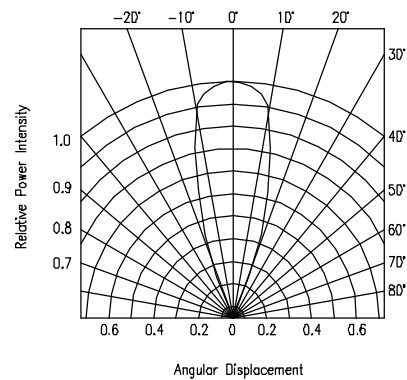
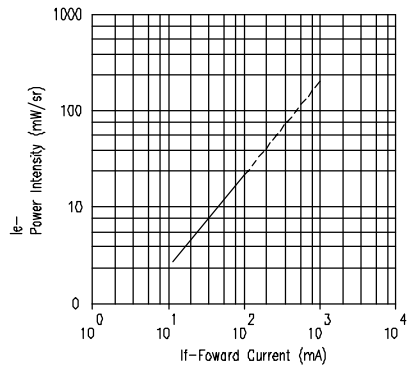
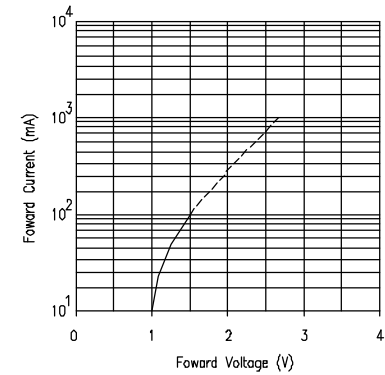
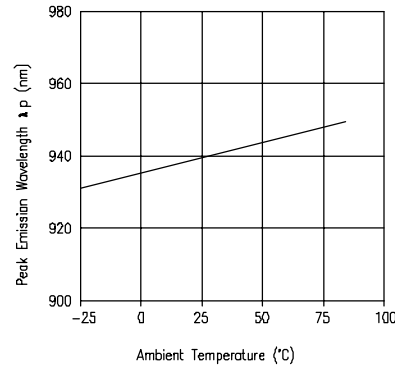
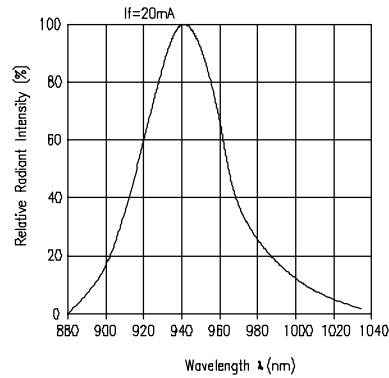
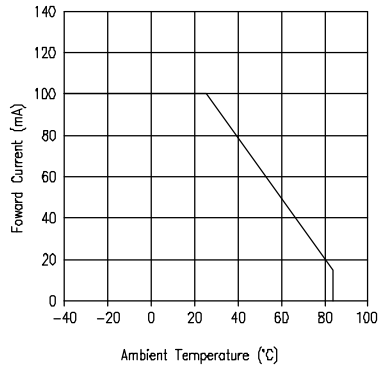

*UNLESS OTHERWISE SPECIFIED TOLERANCES PER DECIMAL PRECISION ARE: X=±1 (±0.039), X.X=±0.5 (±0.020), X.XX=±0.25 (±0.010), X.XXX=±0.127 (±0.005). LEAD SIZE=±0.05 (±0.002), LEAD LENGTH=±0.75 (±0.030). MIN.= +DECIMAL PRECISION -0.00 MAX.= +0.00 -DECIMAL PRECISION

REV.
D

PART NUMBER
OED-EL-8L

CONFIDENTIAL INFORMATION
THE INFORMATION CONTAINED IN THIS DOCUMENT IS THE PROPERTY OF LUMEX INC. EXCEPT AS SPECIFICALLY AUTHORIZED IN WRITING BY LUMEX INC., THE HOLDER OF THIS DOCUMENT SHALL KEEP ALL INFORMATION CONTAINED HEREIN CONFIDENTIAL AND SHALL PROTECT SAME IN WHOLE OR IN PART FROM DISCLOSURE AND DISSEMINATION TO ALL THIRD PARTIES.



290 E. HELEN ROAD
PALATINE, IL 60067-6976
PHONE: +1.847.359.2790
US WEB: www.lumex.com
TW WEB: www.lumex.com.tw



T-3mm, 940nm INFRARED EMITTER, WATER CLEAR LENS.

RELIABILITY NOTE
OUR MANY YEARS OF EXPERIENCE DATA ACCUMULATION INDICATE THAT SOLDER HEAT IS A MAJOR CAUSE OF EARLY AND FUTURE FAILURE. PLEASE PAY ATTENTION TO YOUR SOLDERING PROCESS.

DRAWN BY:

BC

CHECKED BY:

APPROVED BY:

DATE: 4.21.93

PAGE: 2 OF 2

SCALE: N/A